

LUCIA-S

~15° spot beam

TECHNICAL SPECIFICATIONS:

Dimensions	89.8 mm
Height	34.7 mm
Fastening	pin, screw
ROHS compliant	yes ⓘ

MATERIAL SPECIFICATIONS:

Component	Type	Material	Colour	Finish
LUCIA-S	Multi-lens	PMMA	clear	



ORDERING INFORMATION:

Component	Qty in box	MOQ	MPQ	Box weight (kg)
C14678_LUCIA-S » Box size: 476 x 273 x 292 mm	64	16		11.0

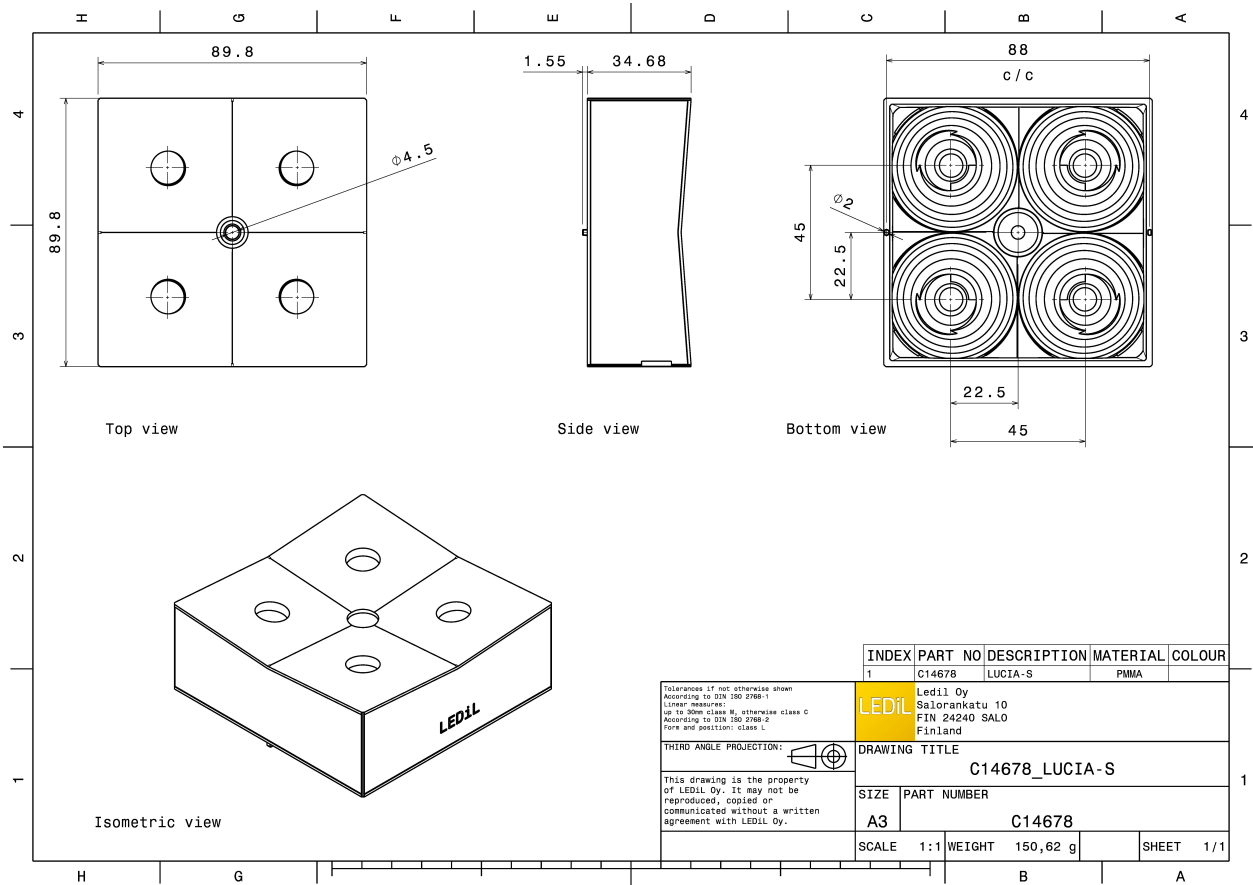

PHOTOMETRIC DATA (MEASURED):

CREE 

LED XM-L RGB
FWHM 13.0°
Efficiency 93 %
Peak intensity 13.360 cd/lm
LEDs/each optic 1
Light colour White
Required components:

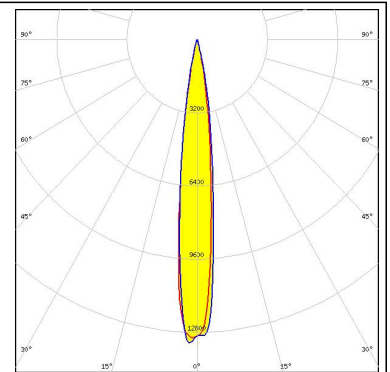

CREE 

LED XP-L HD
FWHM 10.0°
Efficiency 94 %
Peak intensity 21.200 cd/lm
LEDs/each optic 1
Light colour White
Required components:

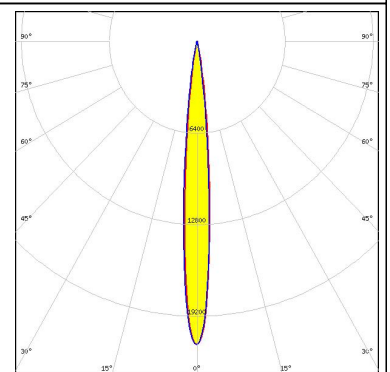

PHOTOMETRIC DATA (SIMULATED):



LED XHP35 HI
 FWHM 8.4°
 Efficiency 94 %
 Peak intensity 30.800 cd/lm
 LEDs/each optic 1
 Light colour White
 Required components:

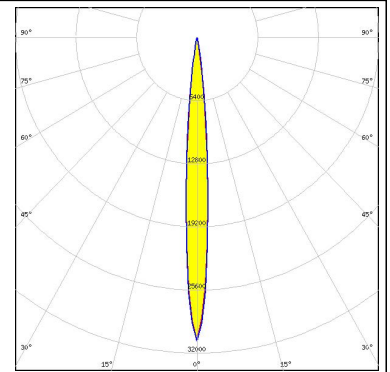

LED XHP50
 FWHM 13.0°
 Efficiency 94 %
 Peak intensity 14.170 cd/lm
 LEDs/each optic 1
 Light colour White
 Required components:

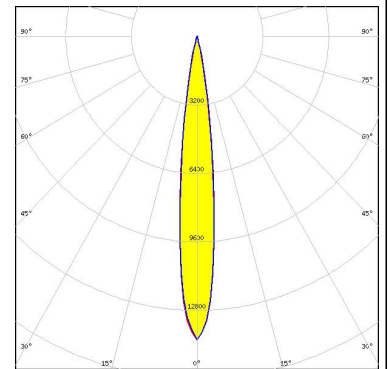

LED XHP50.2
 FWHM 13.0°
 Efficiency 94 %
 Peak intensity 12.870 cd/lm
 LEDs/each optic 1
 Light colour White
 Required components:

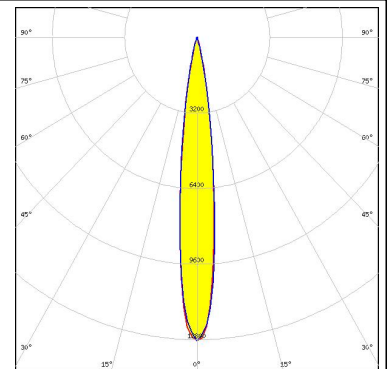

LED XHP70
 FWHM 18.0°
 Efficiency 91 %
 Peak intensity 8.220 cd/lm
 LEDs/each optic 1
 Light colour White
 Required components:

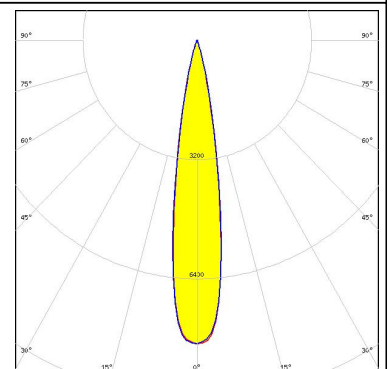

PHOTOMETRIC DATA (SIMULATED):



LED XP-E2
 FWHM 7.0°
 Efficiency 94 %
 Peak intensity 41.668 cd/lm
 LEDs/each optic 1
 Light colour White
 Required components:

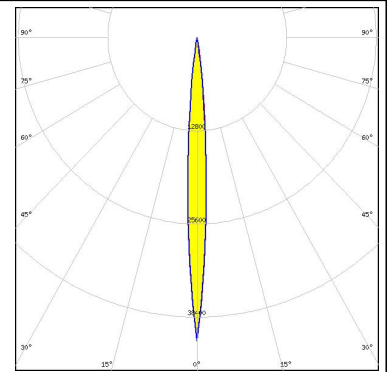

LED LUXEON M/MX
 FWHM 14.0°
 Efficiency 93 %
 Peak intensity 12.610 cd/lm
 LEDs/each optic 1
 Light colour White
 Required components:

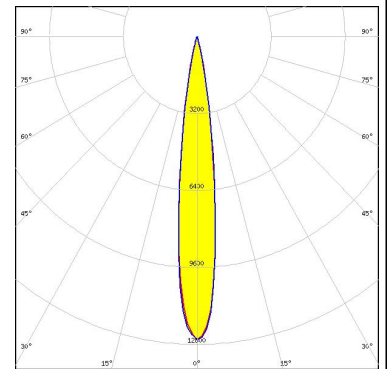

LED LUXEON MZ
 FWHM 10.0°
 Efficiency 94 %
 Peak intensity 23.730 cd/lm
 LEDs/each optic 1
 Light colour White
 Required components:

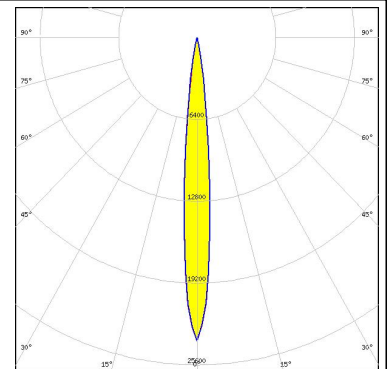

LED Duris S10
 FWHM 13.0°
 Efficiency 94 %
 Peak intensity 12.900 cd/lm
 LEDs/each optic 1
 Light colour White
 Required components:

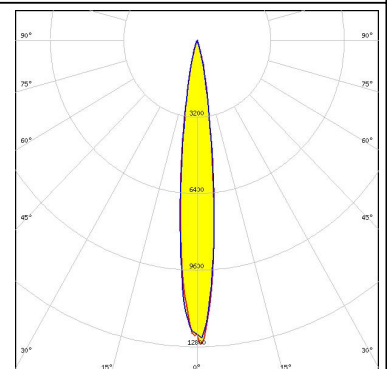

PHOTOMETRIC DATA (SIMULATED):

OSRAM
Opto Semiconductors

LED OSCONIQ P 7070
FWHM 13.0°
Efficiency 94 %
Peak intensity 15.000 cd/lm
LEDs/each optic 1
Light colour White
Required components:

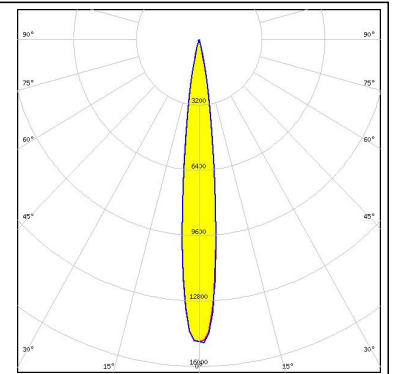

GENERAL INFORMATION:

NOTE: The typical beam angle will be changed by different color, chip size and chip position tolerance. The typical total beam angle is the full angle measured where the luminous intensity is half of the peak value.

MATERIALS:

As part of our continuous research and improvement processes, and to ensure the best possible quality and availability of our products, LEDiL reserves the right to change material grades without notice.

PRODUCT DATA USER AGREEMENT AND DISCLAIMER:

The measured data in the provided downloadable LEDiL Product Datasheets and Mechanical 2D-Drawings is rounded and provided as reference for planning. LEDiL Oy's optical specifications have been verified by conducting performance testing of the products in accordance with the company's quality system. The reported data are averaged results of multiple measurements with typical variation. LEDiL Oy reserves the right to without prior notification make changes and improvements to its products.

LEDiL Oy assumes neither warranty, nor guarantee nor any other liability of any kind for the contents and correctness of the provided data. The provided data has been generated with highest diligence but the provided data may in reality not represent the complete possible variation range of all intrinsic parameters. Therefore, in certain cases a deviation from the provided data could occur.

LEDiL Oy reserves the right to undertake technical changes of its products without further notification which could lead to changes in the provided data. LEDiL Oy assumes no liability of any kind for the possible deviation from any provided data or any other damage resulting from the usage of the provided data.

The user agrees to this disclaimer and user agreement with the download or usage of the provided files.

LEDiL Oy

Joensuunkatu 13
FI-24240 SALO
Finland

LEDiL Inc.

228 West Page Street
Suite D
Sycamore IL 60178
USA

Local sales and technical support

[www.ledil.com/
where_to_buy](http://www.ledil.com/where_to_buy)

Shipping locations

Salo, Finland
Hong Kong, China

Distribution Partners

[www.ledil.com/
where_to_buy](http://www.ledil.com/where_to_buy)